



# PFD GUIDANCE FOR COMMERCIAL FISHING



Lifeboats



# Personal Floatation Devices

Useless unless worn



# CONTENTS



## Lifeboats

Contents	3
Importance	4
Choosing	8
Fitting	14
Maintaining	18



FISG (Fishing Industry Safety Group) can best be described as a team of experts working together to provide ways which allow fishermen to take responsibility for their safety and reduce preventable deaths down to ZERO. Is this achievable? It has been achieved in other countries so why not in the UK?

FISG membership comprises of Fishermen's Federations, Seafish, MCA, MAIB, RNLI, MMO, Fishermen's Mission, Ship Builders and Insurers. Other organisations can be invited as and when required. What has been achieved through FISG? Free training for fishermen and updated safety training courses are two results you will have seen. The Seafish Under 16.5m Skipper's Certificate also came about through FISG, previously there was no certificate available, FISG has worked to maximise its uptake through free funding, raising awareness of it through MGN411 and ensuring it can be used on Coded vessels as well.

FISG produces a free annual Safety CD providing access to safety information from many of the member organisations. Contact the NFFO by phone on 01904 635 430 or by email [nffo@nffo.org.uk](mailto:nffo@nffo.org.uk) for a free copy.

In the pipeline are ways to help with risk assessments, port safety workshops, videos by fishermen for fishermen, internet blogs and safety news etc.

**“Wear a PFD (Personal Floatation Device) it can save your life!” – FISG**

# IMPORTANCE OF WEARING YOUR PFD

## Why Wear?

**103 fishermen have died from drowning since 1992 (MAIB data). 31 from over 24m vessels, 36 from 15 – 24m vessels, 39 from small vessels. The size of the vessel does not matter. Over 99% of these fishermen were not wearing lifejackets (MAIB).**

### Staying on the boat

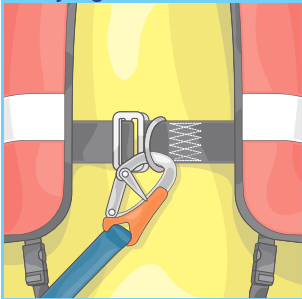

This is one of the most important factors about any type of fishing, it is important to keep decks clear from unnecessary clutter and trip hazards, using a lifeline where practical should be adhered to. A lifeline can keep you onboard, or should you go over the side, a PFD gives you a good chance of staying afloat.

### PFD Standards

There are four European standards for PFDs which must all carry the CE mark (EN393-399). Those standards have been recently replaced by the International Standards Organisation (ISO) and are known as ISO 12402.

### Buoyancy aid - Level 50



Buoyancy aids with 50N are recommended for use by swimmers in sheltered waters or watersports where help is close at hand. They do not have sufficient buoyancy to protect a person who is unable to help themselves and unlikely to turn a person from a face down position in the water.



## Lifejacket - Level 100



The 100N lifejackets are recommended if you are likely to be in sheltered and calm water. It may not have sufficient buoyancy to protect a person who is unable to help themselves and may not roll an unconscious person on to their back, particularly if they are wearing heavy clothing.



## Lifejacket - Level 150

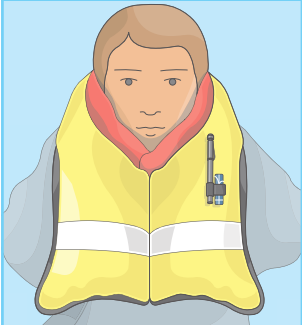

**The 150N lifejacket is for general use on coastal and inshore waters.** It is intended for general offshore and rough weather use where a high standard of performance is required. It should turn an unconscious person onto their back and requires no subsequent action by the wearer to keep their face out of the water. Its performance may be affected if the user is wearing heavy and/or waterproof clothing.



## Lifejacket - Level 275

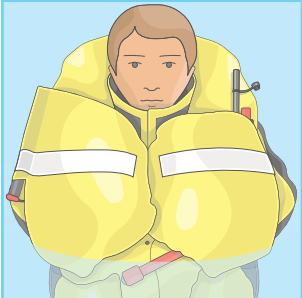

The 275N lifejacket recommended for offshore use, primarily for extreme conditions and for those wearing heavy protective clothing that may adversely affect the self-righting capacity of lesser lifejackets. This lifejacket is designed to ensure that the wearer is floating in the correct position with their mouth and nose clear of the surface of the water.



# IMPORTANCE OF WEARING YOUR PFD

## Types of inflation

There are three inflation methods of gas-only lifejackets. It is important to know which method your lifejacket uses and how it works.

### Automatic

Automatic lifejackets always have a means of manual activation in addition to a mouth piece to allow the lifejacket to be inflated orally. Automatically inflated lifejackets rely on a small pellet or bobbin which holds back a powerful spring. When the pellet contacts water it dissolves very rapidly, releasing the spring which pushes a firing pin into the gas canister. Most fishermen will wish to have a lifejacket that will inflate automatically if they are in the water.

### Manual

Manually inflated lifejackets are operated by pulling a string which pushes a firing pin into the CO<sub>2</sub> canister which inflates the lifejacket. Manual activation prevents the possibility of false activation due to a damp automatic mechanism or, the concern of an automatic lifejacket inflating whilst the wearer is trying to struggle out of a sinking vessel. Of course, manual activation will not work if you are unconscious!

### Hydrostatic (Hammar)

Hydrostatic or Hammar action lifejackets work the same way as an automatic lifejacket, with a dissolving pellet, but the pellet is protected by a case that only lets water in once it is a few centimetres under water. It won't fire until you fully submerge it in water. Both the automatic and hydrostatic jackets have a manual pull string as a back up.

## What the law demands

The MCA are introducing three new voluntary MGNs which can be used instead of the current Codes and Regulations which apply to small FVs (under 15m LOA), 15-24m FVs and larger FVs (Over 24m); these Codes are based on the lessons to be learned from MAIB investigations.

A key finding has been that many of those who lost their lives were not wearing a PFD or lifeline when working on the open decks of a FV whilst at sea.

**A panel of experts has found that of the 33 fishermen who went overboard and lost their lives between 2007 and 2011, 26 would possibly or probably survived if they had been wearing a PFD.**

## Cold Water Shock

This is the uncontrollable reaction of your body when you hit the water for the first few minutes. There is a large gasp reflex followed by a four fold increase in breathing rate and associated increases in heart rate and blood pressure. **You get through this period relatively quickly (3-5 min), but while it lasts it could kill, as you are unable to focus on breathing in this phase.**

Imagine it, the waves lapping in your face, your mouth is close to the water, and, if nothing else, you are susceptible to things like a heart-attack and so on. The energy expended during this stage, the clothing and fitting of a lifejacket are all critical factors to survive through these first few minutes (see illustration below). From then on, keeping warm, concentrating on staying afloat and being visible are key concerns. In a group adopt the Huddle position and if on your own adopt the Help position.



Help position

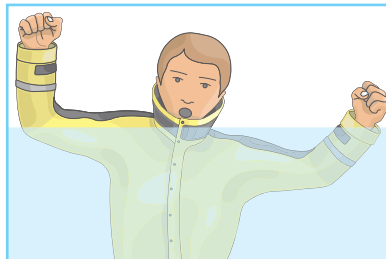

Gasp reflex



With crotch straps



Huddle position



Without crotch straps

# CHOOSING YOUR PFD

## Horseshoe

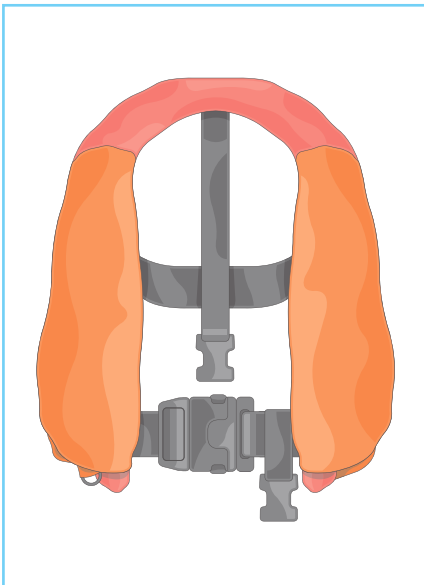

These are the products that most fishermen will consider as they can be worn over any clothing and are lightweight and unrestricting. However, there is a lot to consider when choosing a product for your circumstances.

### Automatic or Manual

Most fishermen will wish to have a lifejacket that will inflate automatically if they are in the water. However, it is possible to specify a 'manual' lifejacket that has to be manually activated by pulling the lanyard toggle. **Of course, manual activation will not work if you are unconscious!**

### Covers

Are secured with press studs, velcro or zip fastenings. The covers need to be robust to protect but also flexible to ensure that the lifejacket is comfortable to wear. For fishing, the ability to be able to keep the covers clean will be a big consideration.

Pros	Cons
Ease of use	Must be well maintained
Good support in water	Must be serviced annually
Will turn an unconscious casualty face up	Bladder prone to damage from sharp objects
Lightweight	



## Buoyant thermal suits



These suits have a major advantage over many products in that they provide thermal protection, giving greatly extended survival time and protection against 'cold shock' when suddenly entering cold water. The suits are made from heavy duty waterproof fabric with a closed cell foam lining that will provide 50-80N of buoyancy. Velcro straps seal the suit at the cuffs and ankles to prevent cold water flushing through. The suits have a thermally lined hood and reflective tapes are usually fitted to the hood, shoulders and cuffs.

In the water the suits provide good support. Swimming is easy and it is also easy to assume an upright position in the water with the mouth well clear, even in wave conditions. However, should the wearer become unconscious, they will float horizontally either 'face up' or 'face down'. For this reason it is recommended that the suits are worn with an inflatable lifejacket to ensure that the wearer is turned 'face up' and due to the lifejacket having to overcome the buoyancy of the suit, a large 275N lifejacket is recommended. Fishermen regularly wear these suits in cold conditions for which they are ideal. However, in warm weather they will simply be too hot to work in.

Pros	Cons
Increased thermal protection	Can be hot to work in during summer months
	Poor level of support in water
	Will not turn an unconscious casualty face up

# CHOOSING YOUR PFD

## Oilskin LJ / Buoyancy aid



The idea of incorporating a lifejacket into the oilskins has much appeal. Placing the lifejacket in the top is one possibility; but quite often the top is not being worn and hence it is preferable to have the lifejacket as part of the oilskin trousers. A special oilskin top with an expansion pleat is available or, a jacket type top that has press studs to fasten it, is suitable to burst open giving space for the inflated lifejacket beneath. One product, which was favoured by many fishermen in trials, replaces the braces of the oilskin trousers with an inflatable lifejacket.

The lifejacket is of a broad flat section and sits comfortably on the wearer's shoulders. Straps attached to the bib of the trousers give adjustment of the fit and the trousers act as an effective crotch strap for the lifejacket when in the water. The lifejacket and the oilskin trousers can be purchased separately so that if the trousers become damaged the lifejacket can be transferred to a new pair.

Pros	Cons
Intergrated into the deckwear	Buoyancy aids can be bulky
Easy to replace damaged units	Will not turn an unconscious casualty face up in the water

Pull out PFD Maintenance Poster



# MAINTAINING YOUR PFD



Lifejackets do not last forever. Regularly inspect your PFD for wear and tear. Whatever type of PFD you use, it will need basic maintenance to keep it working properly. There is no reason why an inflatable lifejacket worn as a PFD should not be inspected by the fisherman following the manufacturer's instructions

**Remember the safest lifejacket is the one that's worn.**

## Monthly Checks

### Visual

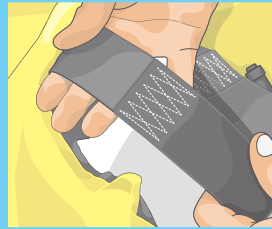

Check the webbing and the stitching that holds the webbing together. Lifejackets with a colour thread, which strongly contrasts with the webbing makes it much easier to spot worn stitching. Also check zips, buckles and other fastenings.

### Bottle integrity – Gas cylinder is tightly screwed in



The screw-in CO<sub>2</sub> cylinders in lifejackets can work themselves

### Oral inflate

Every month inflate the lifejacket orally. Leave it inflated for 24 hours in a dry environment to ensure there are no leaks or damage. Repack the lifejacket according to the manufacturers folding instructions.

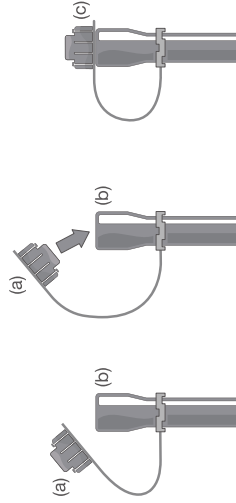

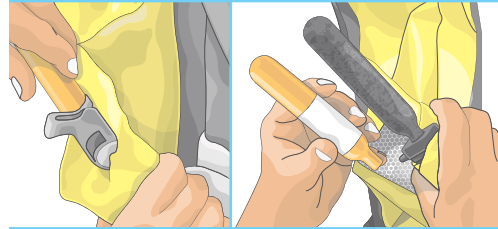

The screw-in CO<sub>2</sub> cylinders in lifejackets can work themselves loose and should be checked for tightness every month. Make sure the bottle has not been fired and is fully armed and ready to be fired from new. Always carry re-arming kits for all types of jacket on board, in case of accidental inflation.

Check the CO<sub>2</sub> bottle for corrosion and signs of rust. A rusty cylinder should be replaced. Also check any areas of material that wear in contact with a rusty cylinder – the fabric may have been damaged.

The lifejacket **MUST** be deflated by reversing the cap (a) on the oral inflation tube and inserting it into the end of the tube (b), hold the cap in the end of the tube during the deflation process. Once the lifejacket has been deflated replace the cap over the end of the oral inflation tube (c). This will prevent dust or particles entering the valve. Using any other method of deflating the lifejacket will result in damage to the oral tube valve, preventing the lifejacket from holding air, which will not be discovered until the lifejacket is used during drills or in a real emergency.

### Annual Service

Every 12 months it is highly recommended that fisherman return their lifejackets to the manufacturer or a qualified service agent for a full service. Wear and contamination from salt spray, fish guts, sand etc could mean that it is possible that it will need replacing within 1-2 years if it is not well looked after and maintained. **If you look after your lifejacket, it will look after you.**

	Jan	Feb	March	April	May	June	July	Aug	Sept	Oct	Nov	Dec
Visual												
Bottle integrity												
Oral inflate												
Annual service												



## Waistcoat



They are looked upon favourably by fishermen as they are easy to wear, comfortable and look just like normal garments. They have a buoyant foam lining that will provide 50-70N of buoyancy, sufficient to keep you afloat but, will not keep you face up if you become unconscious. They typically have a zip fastener and good sized useful pockets and are modestly priced. Many skippers find them ideal for wearing in the wheelhouse but, crew members working on deck, may find them too hot to work in during warm weather conditions.

## Hazards

Look for a lifejacket with a flat profile that fits you closely and does not extend down much below the chest.

**The major snag point is liable to be the bead or toggle for activating manual inflation, which is usually located at the bottom.**

Pros	Cons
Increased thermal protection	Can be hot to wear in summer months
Good freedom of movement	Poor level of support in water
Easy to use	Will not turn an unconscious casualty face up in the water

# CHOOSING YOUR PFD

## Features

There are many features on a lifejacket that can greatly enhance your chances of survival and buy you extra time in the water to be found alive. Some of these features are now standard on a lot of lifejackets but here we look at what they can do for you and why they are so important.

## Crotch straps

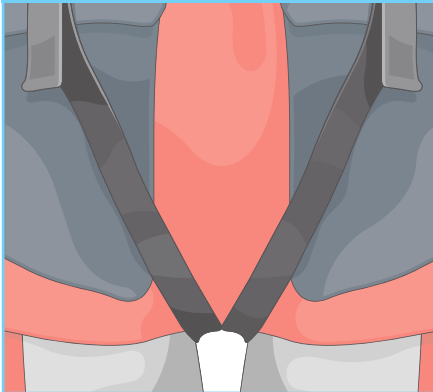

Whether you have one or two crotch straps, by fitting these and wearing them it will stop the lifejacket going over your head. The difference can be quite significant.

## Spray Hood

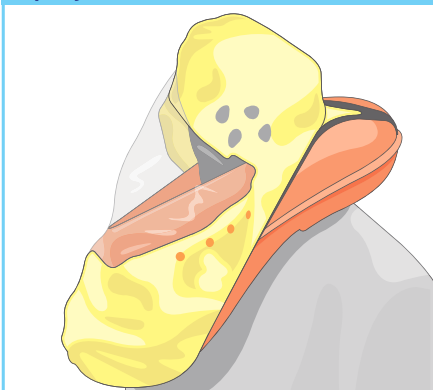

Even with a 150N lifejacket you may be subjected to having waves go over your head, so a lifejacket with a spray hood is a vital piece of equipment that will keep wind-blown spray away from your airways making it easier to breathe and reducing the risk of drowning. It will also double up as a high visibility detection aid as well as stopping heat escape from your head. A good spray hood will be one with air vents at the side.



### Strobe

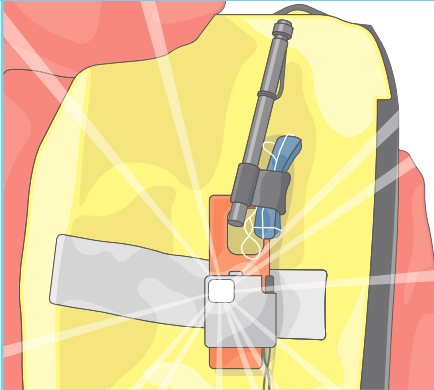

A flashing light or strobe attached to your lifejacket makes you much easier to find at night or times of poor visibility and can be easily attached by yourself.

### Whistle



The attachment of a whistle even on a non SOLAS approved PFD will increase your chances of being detected while floating on the surface. It is a low cost addition to your personal safety kit.

# TYPES OF FITTING FOR PFDs

Fitting your lifejacket may seem a simple task for many people, but these items can still challenge the most experienced. Here we look at donning your PFD, the different methods of securing it and then correctly adjusting by showing the differences.

## Fastening your PFD

### Buckles

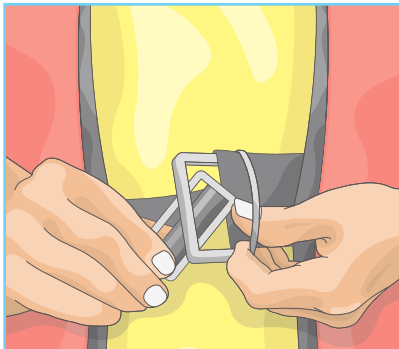

1

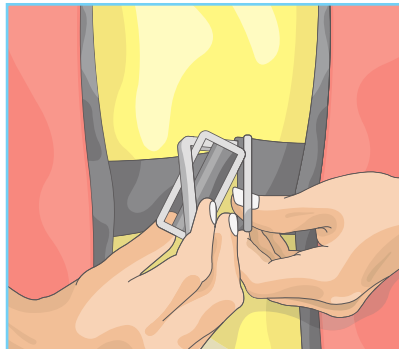

2

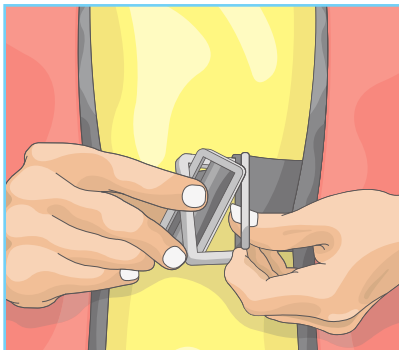

3

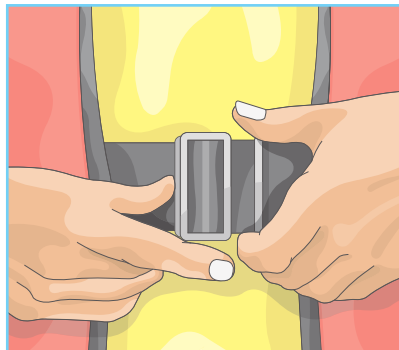

4

## Buckles

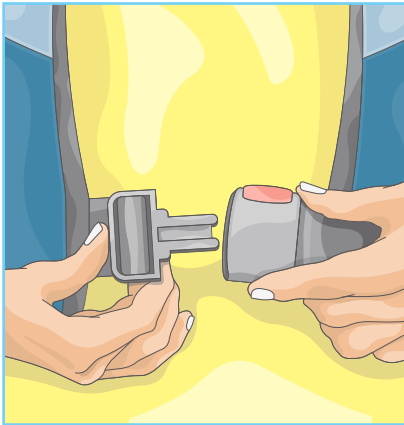

CLUNK

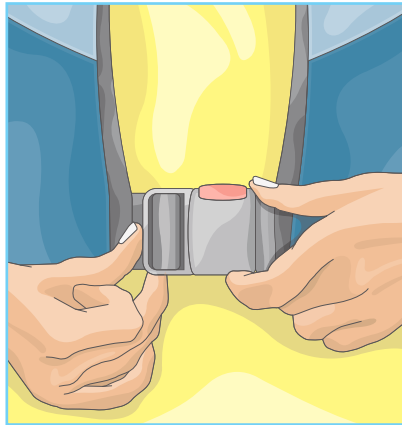

CLIP

## Zips



1



2



3

# FITTING YOUR PFD

## Fitting your PFD

Once you have a lifejacket that is the correct size for you, it is vital that you fit it correctly. Secure crotch straps if fitted and make sure all straps are firmly adjusted. Unless the lifejacket belt is securely fastened tightly to the wearer the lifejacket will simply float up above the shoulders when in the water. The buckle needs to be easy to use and effective to ensure that the belt does not work slack. Once again there are a few methods to tightening your lifejacket and you should be familiar with which method you have.

### Side fastening

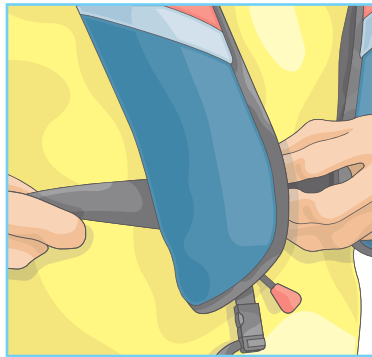

Adjust either whilst wearing or before you fit.

### Pull to fit



The straps are 'rocked' forwards and backwards to obtain a tighter fit.

## Fit



**Good fit**

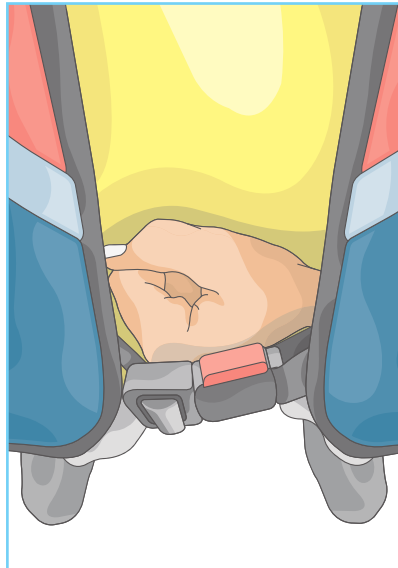

**Bad fit**

Once you have your lifejacket tightened a quick test is to place your fist underneath the buckle. If there is a gap between your fist and your clothing then the lifejacket is a little loose. If you cannot physically get your fist under your lifejacket then you may wish to loosen your lifejacket for comfort.

NB – Remember to tuck away all loose straps to reduce the risk of snagging.

# MAINTAINING YOUR PFD

Lifejackets do not last forever. Regularly inspect your PFD for wear and tear. Whatever type of PFD you use, it will need basic maintenance to keep it working properly. There is no reason why an inflatable lifejacket worn as a PFD should not be inspected by the fisherman following the manufacturer's instructions.

**Remember the safest lifejacket is the one that's worn.**

## Monthly Checks

### Visual

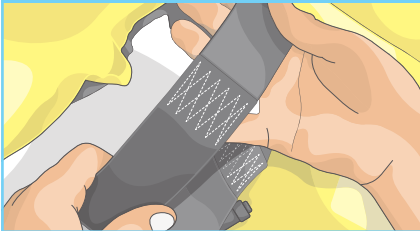

Check the webbing and the stitching that holds the webbing together. Lifejackets with a colour thread, which strongly contrasts with the webbing makes it much easier to spot worn stitching. Also check zips, buckles and other fastenings.

### Bottle integrity - Gas cylinder is tightly screwed in

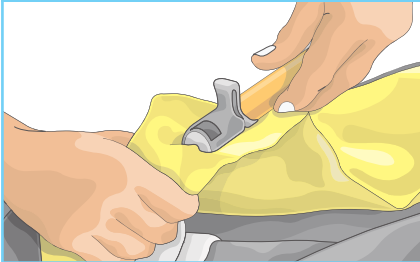

The screw-in CO<sub>2</sub> cylinders in lifejackets can work themselves loose and should be checked for tightness every month. Make sure the bottle has not been fired and is fully armed and ready to be fired from new. Always carry re-arming kits for all types of jacket on board, in case of accidental inflation.

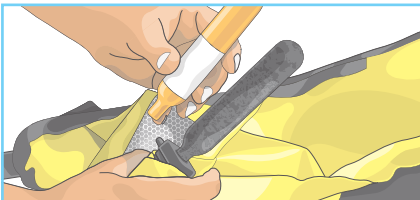

Check the CO<sub>2</sub> bottle for corrosion and signs of rust. A rusty cylinder should be replaced. Also check any areas of material that wear in contact with a rusty cylinder – the fabric may have been damaged.

## Oral inflate

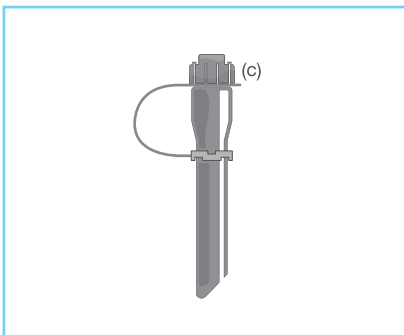
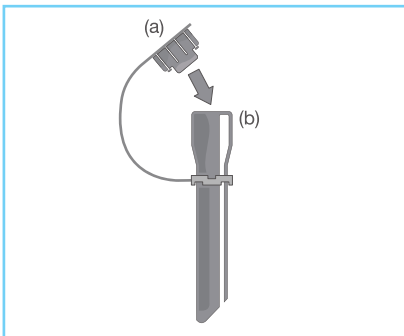
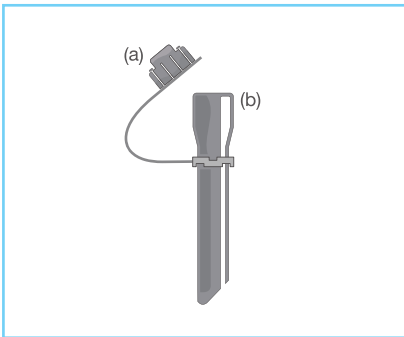

Every month inflate the lifejacket orally. Leave it inflated for 24 hours in a dry environment to ensure there are no leaks or damage. Repack the lifejacket according to the manufacturers folding instructions.

The lifejacket **MUST** be deflated by reversing the cap (a) on the oral inflation tube and inserting it into the end of the tube (b), hold the cap in the end of the tube during the deflation process. Once the lifejacket has been deflated replace the cap over the end of the oral inflation tube (c). This will prevent dust or particles entering the valve. Using any other method of deflating the lifejacket will result in damage to the oral tube valve, preventing the lifejacket from holding air, which will not be discovered until the lifejacket is used during drills or in a real emergency.

## Annual Service

Every 12 months it is highly recommended that fisherman return their lifejackets to the manufacturer or a qualified service agent for a full service.

Wear and contamination from salt spray, fish guts, sand etc could mean that it is possible that it will need replacing within 1–2 years if it is not well looked after and maintained. **If you look after your lifejacket, it will look after you.**



This leaflet has been produced to support working fishermen whose interests are at the heart of a group called the Fishing Industry Safety Group (FISG); FISG has representation from all sectors of the industry (Associations, Federations, Owners, Agents, FV builders, Insurers, RNLI, MMO and the MCA).